

HARMONY

cucinense



HARMONY



ELEGANCE

METROPOLITAN

EASY

SHABBY

CLASSIC





ELEGANCE

“Ideata per chi ama la sobrietà e che non intende rinunciare ad un’ eleganza contemporanea e senza tempo, Harmony ridefinisce gli schemi tradizionali della cucina scegliendo soluzioni creative basate su una continua ricerca di materiali e finiture, in grado di ricreare atmosfere naturali, per un ambiente elegante che lega cucina e living in architetture inedite e personalizzabili.”

“Dedicated to those who love soberness, elegance and to whom doesn’t want to give up on a contemporary yet timeless elegance, Harmony redefines the traditional kitchen schemes choosing creative solutions based on a continuous and on-going research of materials and finishes, capable of recreating natural atmospheres, for an environment which unifies the kitchen and the living area through unexpected, distinctive and customizable architectures.”

“Pensée pour ceux qui aiment la sobriété sans pour cela renoncer a une élégance contemporaine et intemporelle, Harmony redéfinit les schémas traditionnels de la cuisine en choisissant des solutions créatives basées sur une recherche continue des matériaux et finitions, pour recréer des atmosphères naturelles, pour une ambiance élégante qui marie la cuisine et le living et ce pour un aménagement inédit et personnalisé.”





» Un progressivo ampliarsi delle prospettive di arredo verso la zona giorno, con soluzioni che abbattano definitivamente i confini tra cucina e living, integrando l'uno nell'altro in composizioni articolate in modo fluido e particolarmente funzionale.

» A progressive widening of the arrangement-perspectives which blend into the living room, through solutions which definitely cut down the boundaries between the kitchen and the living room, integrating the one with the other in compositions articulated in a very fluid and extremely functional way.

Un élargissement progressif des perspectives d'aménagement vers le séjour, avec des solutions qui unissent ces deux espaces en les intégrant l'un à l'autre, grâce à des compositions articulées avec fluidité et particulièrement fonctionnelles.





01»»





La cucina Harmony dilata le sue funzioni di operatività domestica, sovrapponendole a quelle del living: originali mobili contenitori a giorno consentono infiniti giochi compositivi che permettono e favoriscono l'integrazione della funzionalità con il proprio lifestyle.



The kitchen Harmony widens its house-hold operating functions, combining them to those of the living area: unique and distinctive open storage elements pave the way for endless compositional possibilities which allow and favour the integration of functionality with your own life-style.

La cuisine Harmony élargit ses fonctions domestiques en les superposant à celles du living: les éléments ouverts et originaux permettent d'infinis jeux de composition afin de favoriser l'intégration de la fonctionnalité avec votre propre style de vie.



ELEGANCE Sinergie d'effetto
Effect synergies
Effet de synergie

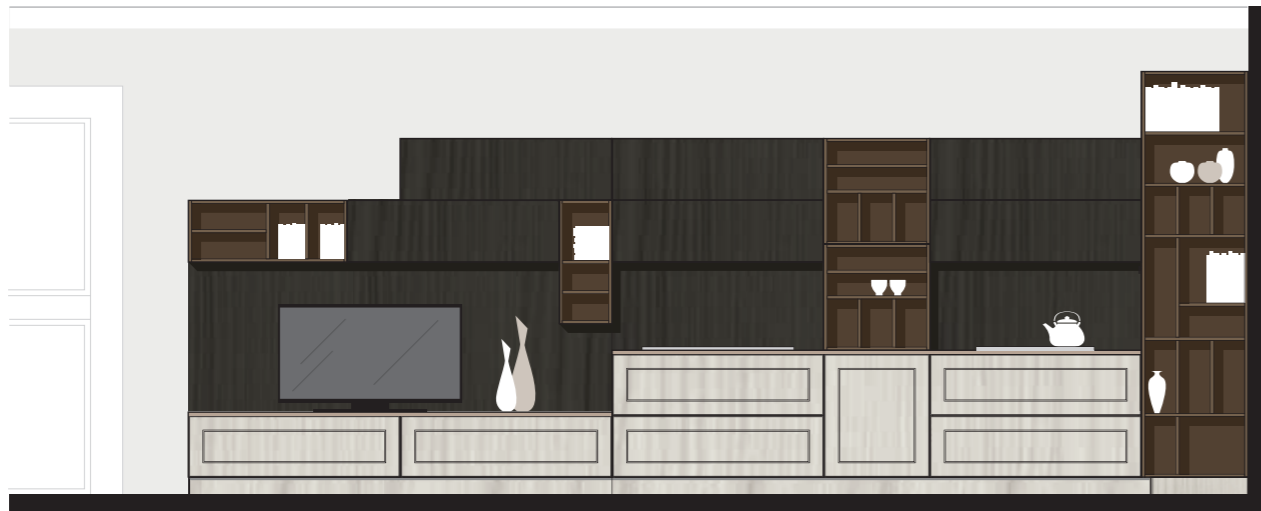

Basi e colonne Harmony grigio light, pensili Krea lava ed elementi a giorno laccato gofrato RAL 7036.

Base and tall units of Harmony model color light grey, Krea wall units color lava and open elements lacquered and embossed color RAL 7036.

Meuble bas et colonnes Harmony gris clair, meubles hauts Krea lava et éléments ouverts laqués mat RAL 7036.

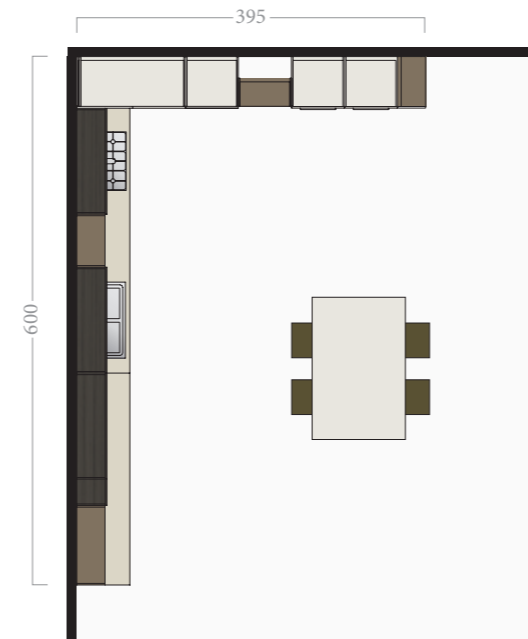

grigio light

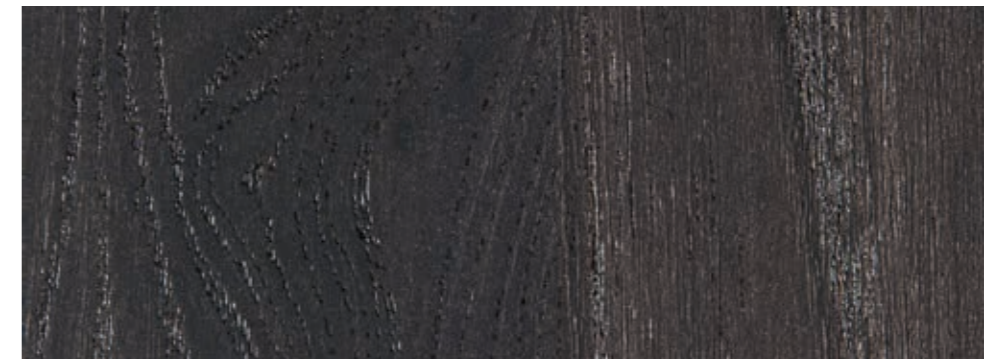

lava



RAL 7036



METROPOLITAN

“Harmony interpreta con disinvoltura l’ambiente cucina contemporaneo e arreda con un gusto accattivante ed estroverso ogni situazione; la versione metropolitana esprime al meglio la sua anima decisa e disinvolta, con un look innovativo in cui gli spazi si liberano da ogni vincolo, diventano aperti, e la cucina non ha più confini nell’immaginario di chi la vive intensamente ogni giorno.”

“Harmony interprets with easiness the contemporary kitchen environment and allows you to arrange it with a very alluring and lively taste; the metropolitan version expresses at its best its clean, sharp and easy soul, with an innovative look in which the spaces free themselves from every limit, becoming open, so that the kitchen has no more boundaries, also in the imaginary of who intensely lives in it, day by bay.”

“Harmony interprète avec facilité l’ambiance de la cuisine contemporaine et s’adapte à toutes les situations et ce avec un goût captivant; la version urbaine exprime au mieux son âme décise et désinvolte, et ce avec un look innovant permettant une liberté des espaces, devenant ouverts, à ce point la cuisine n’a plus de frontières dans l’imaginaire de la personne qui la vit intensément au quotidien.”





PEOPLE
Forget may
what you
said
WHAT DID
you
THEY
will

8

VICTO



» Le ante con maniglia integrata nel telaio presentano un nuovo stile in cucina e non passano inosservate; la versatilità della cucina Harmony di abbinarsi perfettamente sia agli elementi a giorno in essenza legno, sia alle dispense a vetro, la rendono unica nel suo genere.

» The doors with integrated handle in the frame show a new style in the kitchen that knows how to not be unnoticed; Harmony's versatility and capability of perfectly matching to both the open elements as well as those in wood essence, and also to the glassed pantries, make it unique in its kind.

Les portes aux poignées intégrées dans le cadre présentent un nouveau style de cuisine originale; la cuisine Harmony se marie parfaitement aux éléments ouverts en bois, mais également aux armoires vitrées, et cela la rend unique en son genre.





8 Palestra ore 16.00

ON

farina
4 uova
1 litro di latte
burro
Pomodori rossi
vino bianco
acqua minerale
pepe-sale
olio

PEOPLE
Forget what
you said
AND
WHAT
TE
ER

02»»





Nuove soluzioni per l'ambiente cucina, in cui le essenze legno ed il colore si accostano senza timore, creando un ambiente originale e adatto a chi sceglie di personalizzare il proprio spazio.

New solutions dedicated to the kitchen environment, in which the wooden essences match fearlessly with each other, creating a unique and original environment, suitable to those who choose to customize their own space at a maximum level.

De nouvelles solutions pour l'aménagement de la cuisine, dans lesquelles les essences de bois et les couleurs se marient à merveille, en créant une ambiance originale et adaptée aux personnes désireuses de personnaliser au maximum leur espace.

METROPOLITAN
Combinazioni irresistibili
Irresistible combinations
Des combinaisons irrésistibles



Basi e colonne Harmony grigio dark, vetro fumè con profilo nero ed elemento a giorno laccato goffrato RAL 5001 e boiserie Krea terra.

Base and tall units of Harmony model color light grey, smoked glass with black profile and open element lacquered and embossed color RAL 5001 and Krea boiserie color ground.

Meubles bas et colonne Harmony gris foncé, verre fumé avec chassis noir et éléments ouverts laqués mat RAL 5001, et boiserie Krea terra (voir Metropolitan).

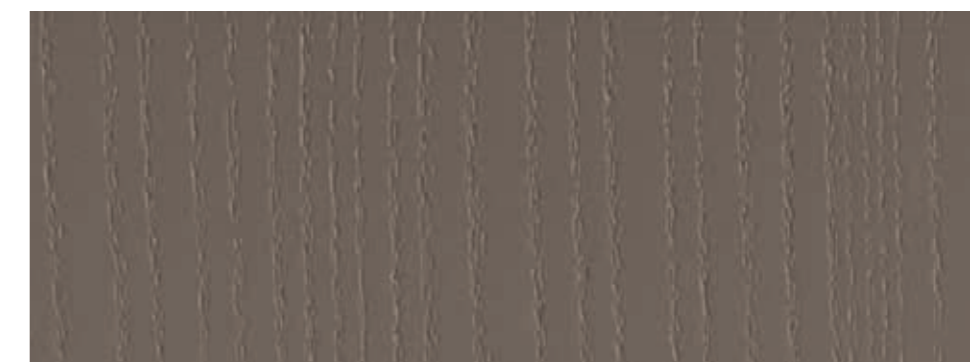

grigio dark



RAL 5001



terra

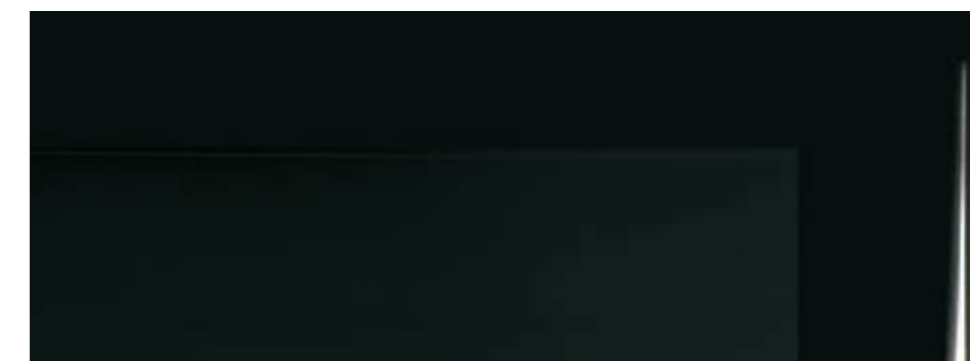

anta vetro fumè



Ce sac peut contenir
vosre attention, votre jean,
vos assiettes, **vosre cœur**,
vos espoirs, vos santiags,
vos fleurs, **vosre confiance**,
vosre amitié, votre pyjama,
vos ballerines, **vos désirs**,
vos idées, vos disques,
vos livres, **vosre soutien...**
Merci.

EASY

“L’ispirazione giunge da un immaginario che si sta conquistando la ribalta nello scenario dei gusti più evoluti. Harmony è un progetto dedicato a chi guarda con occhio nuovo, per nulla nostalgico, alle forme del passato più recente, che reinterpreta in chiave design-oriented l’anta a telaio, abbinandola all’anta liscia e alternandola agli elementi a giorno, in una più ampia concezione del mobile da cucina che si fonde all’ambiente living.”

“The inspiration comes from an imaginary which is becoming the prevailing trend among the actual scenery of the most evolved furnishing tastes. Harmony is a project dedicated to whom looks in a new way, definitely not nostalgic, to the shapes used in the most recent past, which reinterprets in a very design-oriented way the framed door, matching it with the smooth door and alternating it to the open elements, enhancing a wider conception of kitchen furnishing which gradually blends into the the living area.”

“L’inspiration provient de l’imaginaire à la conquête des scénarios aux goûts les plus évolués. Harmony est un projet dédié à qui regarde d’un nouvel oeil, sans nostalgie, aux formes du passé le plus récent, avec une réinterprétation design de la porte sur cadre, en la combinant avec la porte lisse et en alternance avec les éléments ouverts, le tout dans la plus ample conception du meuble de cuisine qui se fonde a l’espace living.”





YOU
+
ME
=
WESOMI

América The Wahl
1900

I
LO
VE
BERG
DAVE

FUTURE
BELIEVE
WASTY
DREAMS

BUY
THE
TICKET
TAKE
THE
RIDE

WASH
A
BOWL
OF
DIP
PAVLOV
CANTINA

Le sac
en papier
moulin

»» *Harmony è una cucina di tendenza e frizzante che, con materiali e tecnologie innovative, esprime la sua personalità multiforme attraverso tratti sempre inediti. È un modello funzionale e brioso, in cui le ante e i contenitori a giorno, di misure e finiture diverse, rivoluzionano la consueta sequenza di moduli tutti uguali. Si compone come un puzzle, rispondendo con disinvoltura e vivacità alle moderne esigenze abitative. Harmony si vive con disinvoltura, senza rinunciare a un'estetica accattivante e distintiva.*

»» *Harmony is a trendy and lively kitchen which, through materials and innovative technologies, expresses its polyhedric personality characterized by increasingly innovative features. It is a functional and very fresh model, in which the doors and the open storage elements, in different sizes and finishes, revolutionize the traditionally usual sequence in which all the modular elements are the same. It is made up of pieces fit together like a puzzle, responding with easiness and liveliness to the modern living needs. Harmony represents a very enjoyable way of living in the kitchen with ease, without renouncing to a captivating and distinctive aesthetics.*

Harmony est une cuisine tendance et pétillante, avec ses matériaux et sa technologie innovante, elle exprime sa personnalité multiforme et ce au travers de ses traits inédits. C'est un modèle fonctionnel et captivant, ses portes et ses éléments ouverts révolutionnent les habitudes des modules toujours identiques. Elle se compose comme un puzzle, en répondant avec désinvolture et vivacité aux exigences modernes de l'habitation. Harmony est vécue avec désinvolture, sans renoncer à une esthétique captivante et distinguée.





BE ORIGINAL

THE PRIVILEGE OF BEING ORIGINAL

I LOVE HOW YOU FEEL

FUTURE BELIEVE BEAUTY DREAMS

SEMPER PARATI

BUY THE TICKET TAKE THE RIDE

YOU + ME = ESOME

Le sac en papier merci

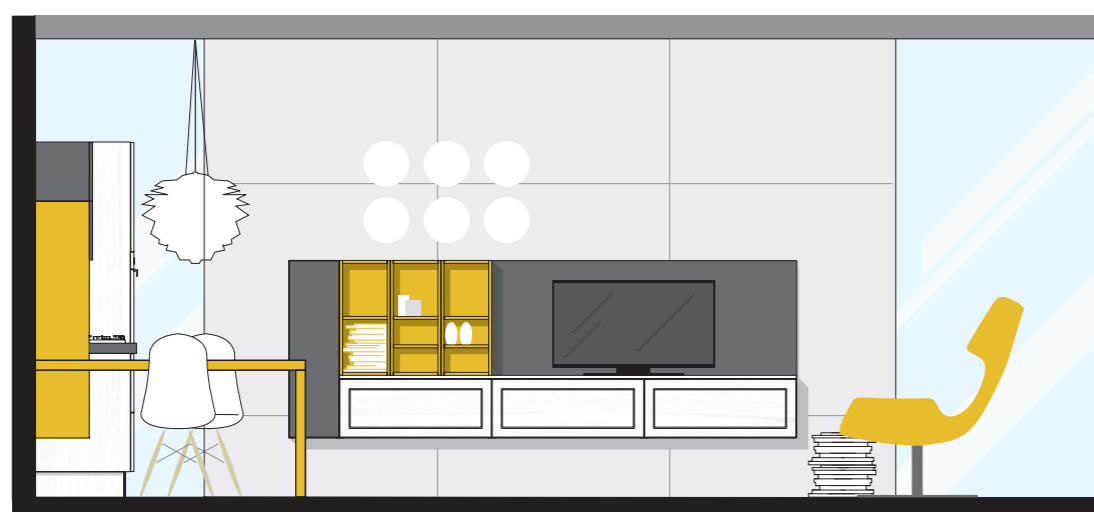

Basi e colonne Harmony bianco, con pensili Mika laccati goffrato ral 7043 ed elementi a giorno laccato goffrato RAL 1012.

Base and tall units of Harmony model color white, with Mika wall units lacquered and embossed color RAL 7043, and open elements lacquered and embossed color RAL 1012.

Meubles bas et colonnes Harmony blanc avec meubles hauts Mika laqués mat RAL 7043 et éléments ouverts laqués mat RAL 1012.

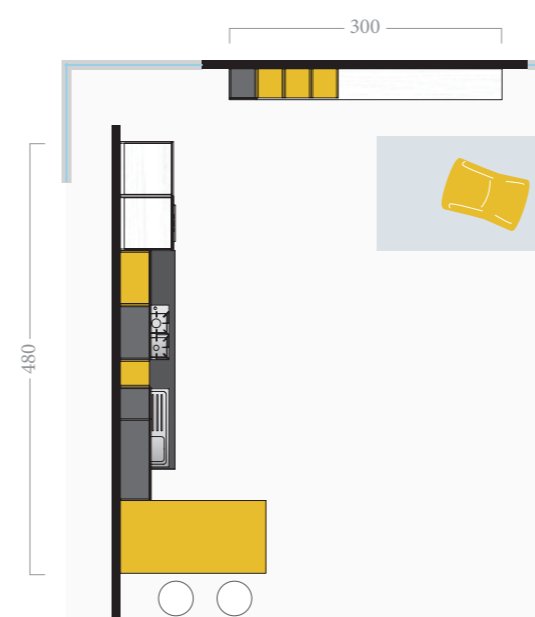

bianco



RAL 7043



RAL 1012



SHABBY

“Un ambiente comodo, rilassante e ricco di atmosfera: Harmony rivela tradizione e cultura artigiana modellati e adattati nel tempo da innovazione e ricerca; offre il sereno equilibrio di soluzioni raffinate, in grado di armonizzarsi perfettamente ai tuoi ritmi quotidiani. Lo stile shabby di Harmony trasmette eleganza, raffinatezza, serenità, attualità e una “memoria” che sa mantenersi pur adattandosi alle necessità dell’oggi.”

“A comfortable environment, relaxing and full of atmosphere: Harmony reveals both tradition and hand-crafted culture, shaped and adapted over time through innovation and research; it allows for a serene equilibrium given by refined solutions, capable of perfectly be in harmony with your daily pace. Harmony’s shabby style enhances elegance, delicateness, serenity, contemporaneity and a “memory” which knows how to preserve itself adapting to today’s life needs, at the same time.”

“Une ambiance agréable, relaxante a l’atmosphère chaleureuse: Harmony révèle la tradition et la culture artisanale et s’adapte à l’innovation et à la recherché; elle offre des solutions raffinées dans un équilibre serein, le tout s’harmonisant parfaitement au rythme quotidien. Le style Shabby de l’Harmony nous transmet l’élégance, le raffinement, la sérénité, la modernité et une “mémoire” qui persiste en s’adaptant aux besoins d’aujourd’hui.”







La cucina è il luogo della casa dove si ritrova l'armonia, si sublima il passato e nascono i racconti della memoria. Harmony rappresenta l'essenza di questo ambiente: la sua atmosfera rassicurante, sottolineata dalle forme eleganti, stimola emozioni intense, e la conferma luogo d'incontro e di convivio.



The kitchen is the home-place where you can easily find harmony, where the past raises, getting almost sublimated and where old memories come to mind. Harmony represents the essence of this environment: its comfortable and reassuring atmosphere, emphasized by its elegant shapes, stimulates intense emotions, making the kitchen the perfect meeting point for conviviality.

La cuisine est l'endroit de la maison où l'on trouve l'harmonie, où l'on sublime le passé et où naissent les histoires de la mémoire. Harmony représente l'essence de cette ambiance, son atmosphère rassicurante et ses formes élégantes, stimulent des émotions intenses tout en confirmant sa convivialité.





04»»





I dettagli della cucina Harmony raccolgono i ricordi in un ambiente armonioso, un giusto compromesso tra poesia e memoria, tra funzionalità e classicismo, con il confort delle forme e la sicurezza dei materiali.

Harmony's details collect the old memories in an harmonious environment, representing the right compromise between poetry and memory, functionality and a taste for classic, between the comfort given by its shapes and the reliability of its materials.

Les détails de la cuisine Harmony nous rappellent les souvenirs d'un espace harmonieux, ils sont un juste compromis entre la poésie et la mémoire, entre le fonctionnel et le classique, avec le confort et la fiabilité de ses matériaux.

SHARRY
Romantica armonia
Romantic harmony
Harmonie romantique

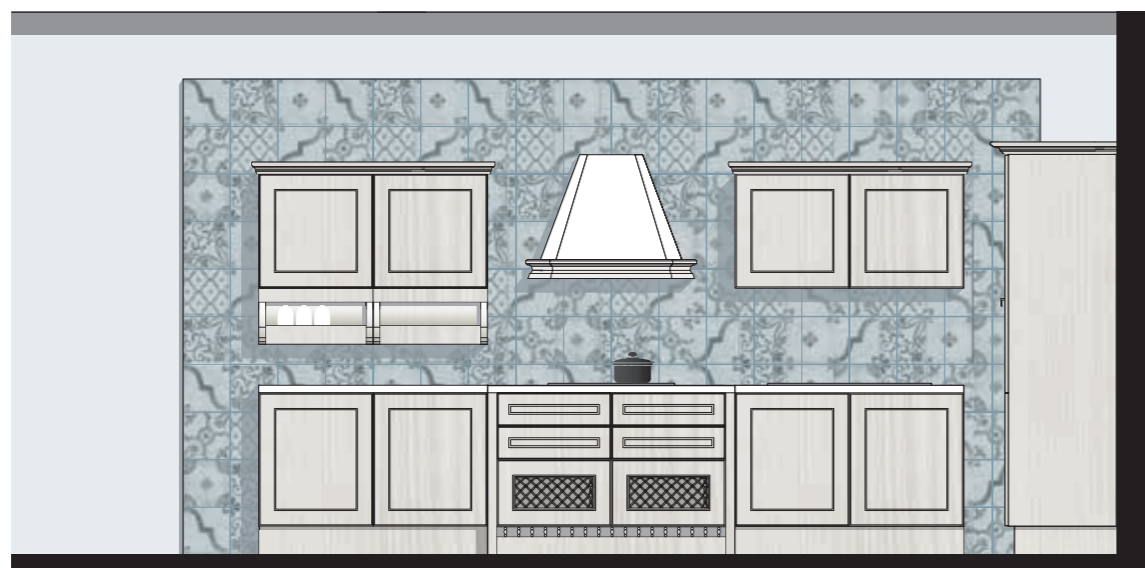

Basi, pensili e colonne Harmony champagne, con cestoni a vetro satinato e grata.

Base, wall and tall units of Harmony model color champagne, with grid-front and satin-glassed baskets.

Meubles bas, meubles hauts et colonnes Harmony champagne, avec paniers coulissants et verre satiné et croisillons.

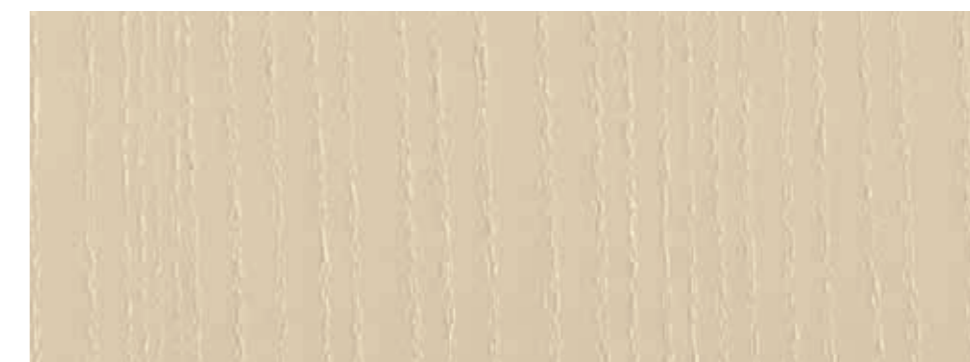

champagne



cestone vetro



cestone con grata

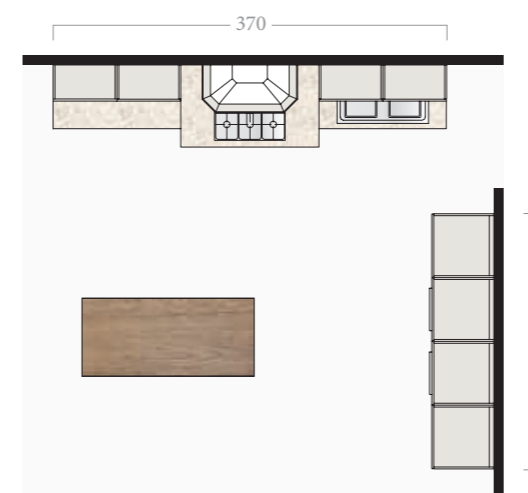



CLASSIC

“L'interpretazione di uno stile classico condotta con un approccio razionale e moderno, mescolando rigore ed eleganza per raggiungere una qualità progettuale capace di assicurare un'esperienza senza tempo: Harmony è tutto questo. Il suo stile e la sua eleganza omaggiano la storia del mobile di classe nei tanti accurati dettagli e la reinterpretano secondo stilemi attuali che si caratterizzano per linearità e coerenza.”

“The interpretation of a classic style guided through a rational and modern approach, mixing rigour with elegance to reach a design-quality capable of ensuring a timeless experience: Harmony is all this. Its style and elegance honor classic furniture history in the various accurate details, and at the same time they reinterpret it through the most actual stylemes, which characterize themselves for linearity and stylistic rigour.”

“L'interprétation d'un style classique avec une approche rationnelle et moderne, mélange de rigueur et d'élégance pour obtenir un projet de qualité capable d'assurer une expérience intemporelle: Harmony est tout ceci. Son style et son élégance rendent hommage à l'histoire du meuble de classe dans tous ses détails recherchés et la réinterprètent suivant un style actuel qui se caractérise par ses lignes et sa cohérence.”





» *Harmony è una cucina in cui il passato si intreccia indissolubilmente al presente per un ambiente ricercato e senza tempo, in cui la seducente combinazione di design e materiali eccellenti trasmettono una sensazione di solidità e durata in uno stile essenziale ed immediatamente riconoscibile.*

» *Harmony is a kitchen in which the past merges indissolubly with the present time to give shape to a refined and timeless environment, in which the alluring combination of design with excellent materials evoke a sensation of solidity and durability through an essential and immediately recognizable style.*

Harmony est une cuisine où se mélangent le passé et le présent pour une ambiance recherchée et intemporelle, la combinaison séduisante du design et des matériaux de premier choix transmettent une sensation de solidité dans le temps, le tout avec style et immédiatement reconnaissable.





05»»





Il rigore estetico, la presenza non ostentata, la percezione di un valore duraturo nel tempo, permangono come caratteristiche portanti del progetto, che risponde con concretezza ed eleganza alle più sofisticate esigenze estetiche e funzionali.

The aesthetic rigour, the non-ostentatiously displayed presence, the perception of a durable, long lasting value, remain as the main features of the project, which responds with concreteness and elegance to the most sophisticated aesthetic and functional demands.

La rigueur esthétique, la présence non ostentatoire, la perception d'une valeur qui dure, sont les caractéristiques principales du projet, c'est une réponse concrète et élégante aux exigences esthétiques et fonctionnelles les plus sophistiquées.

CLASSIC
Il fascino del classico
The charm of Classic
Le charme du classique

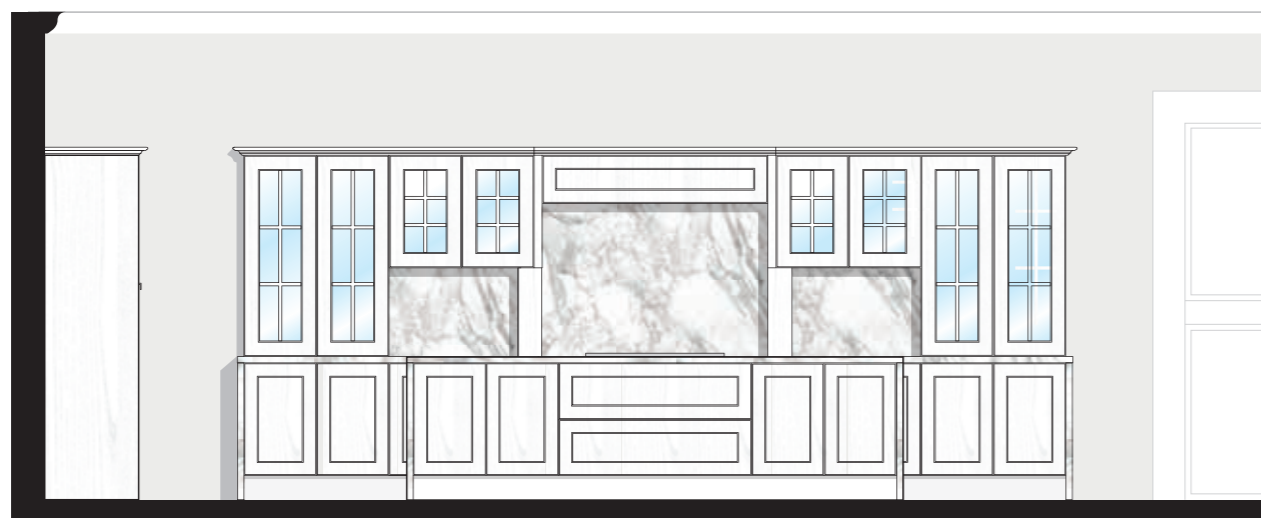

Basi, pensili e colonne Harmony bianco, con ante a telaio con vetro satinato o trasparente.

Base, wall and tall units Harmony model color white, with framed doors including satin or transparent glass.

Meubles bas, meubles hauts et colonnes Harmony blanc, avec portes sur cadre avec verre satiné ou transparent.

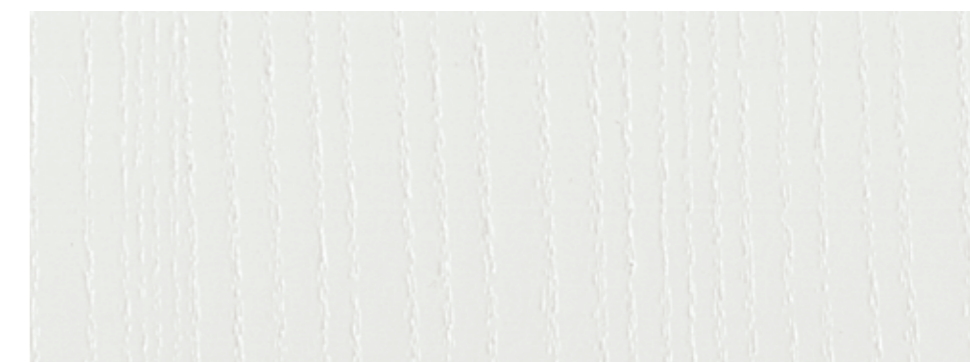

bianco



anta vetro

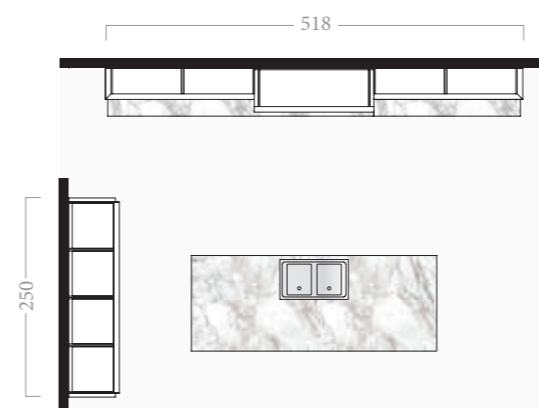





Ricca di charme e dal fascino d'oltre tempo, Harmony trasferisce l'immagine del classico di lusso e lo reinterpreta in chiave moderna, ispirandosi ai valori progettuali di sempre e rendendosi espressione nel buon gusto tipico della cultura italiana.

Characterized by a timeless charm, Harmony shifts from the conceptual image of a luxurious classic to reinterpret it in a modern way, taking inspiration from the timeless design key-values, becoming the expression of a classy, refined taste, typical of Italian culture.

Avec charme et le goût du passé, Harmony transporte l'image du classique de luxe et la reinterprète en version moderne, en s'inspirant des valeurs de toujours et témoignent du bon goût typique de la culture italienne.



FINITURE

FINISHES / FINITIONS



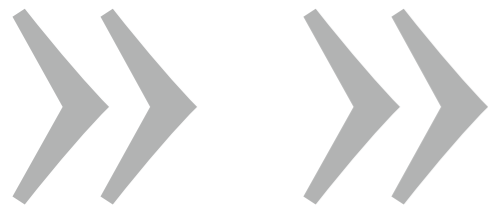

ANTE HARMONY

HARMONY DOORS / HARMONY PORTES

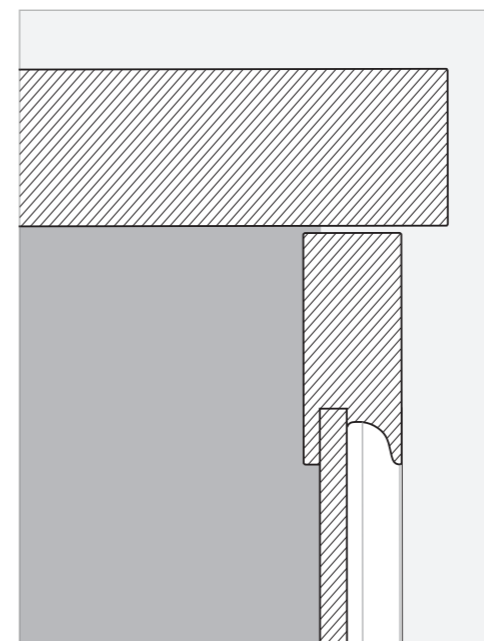
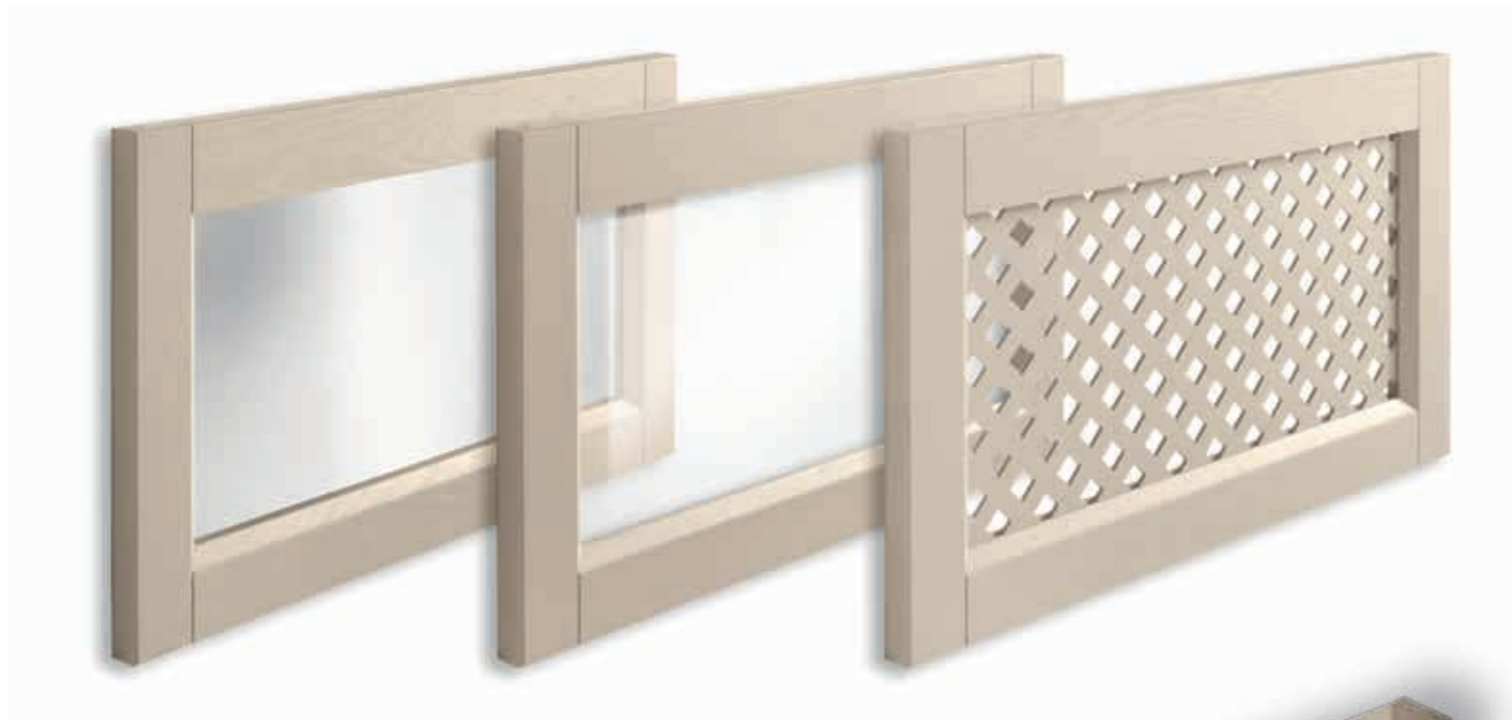

Anta in frassino a poro aperto sp. 24 mm con cartella impiallacciata con tranciato di frassino e con maniglia ricavata su un traverso.

Open-pore ash door, 24 mm thick, with veneered ashlar in ash veneer and handle obtained on a rail.

Porte en frêne avec veinage ouvert ep. 24 mm avec panneau central en placage de frêne et avec poignée intégrée au cadre.



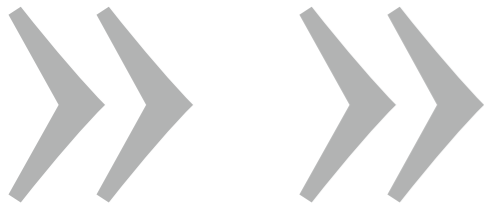

FINITURE ANTE HARMONY

ANTA IN FRASSINO A PORO APERTO

*HARMONY DOOR FINISHES / OPEN-PORE ASH DOOR
HARMONY FINITIONS DES PORTES / PORTE EN FRÊNE À VEINAGE OUVERT*

Bianco / white / blanc

Grigio light / light gray / gris claire

Magnolia / magnolia / magnolia

Grigio dark / dark gray / gris foncé

Champagne / champagne / champagne

* A richiesta, disponibilità di poter fare anta a colore campione con maggiorazione di prezzo, vedi listino.
Il modello Harmony si presta a essere abbinato a tutti gli altri modelli della produzione Cucinense.

*On demand, possibility to produce doors on sample colors with a price surcharge, see price list.
The model Harmony can be matched to all the other kitchen models from Cucinense's production.*

*Sur demande, possibilité de faire les portes avec couleur sur base d'un échantillon avec augmentation de prix, voir tarif.
Le modèle Harmony peut être combiné à tous les autres modèles de la production Cucinense.*

cucinesse

Design made in Italy

» Crediamo che dietro il duro lavoro quotidiano di Sergio Pazzaglia, imprenditore dal 1979, ci fosse un sogno, che magari non faceva nemmeno immaginare tutto quello che oggi ha costruito. Un processo ed un percorso aziendale guidati e condotti per farne partecipi tutti: famiglia, collaboratori, dipendenti, fornitori e tessuto sociale. Un gruppo familiare affiatato e con gli stessi ideali; passione per il proprio lavoro, sacrificio, dialogo aperto e leale esteso all'intera azienda, ai fornitori, alle collaborazioni con giovani designer e Architetti che, insieme, rendono Cucinesse un'azienda proiettata nel futuro con l'impegno di renderlo migliore. Cucinesse non è una persona sola, è la somma delle sue risorse: un'azienda che si è strutturata e s'identifica sulla forza umana che la compone. Un'azienda in continua evoluzione che ha saputo crescere in sintonia con i cambiamenti del mercato ed affermare il suo nome nei principali mercati e che ancora deve conoscere i suoi risvolti più belli.

We believe that behind the hard daily work of Sergio Pazzaglia, entrepreneur from 1979, there pits a dream, that first has imagined everything that has built up until today. A trial and business run in order to make everyone participate in it: family, collaborators, staff, suppliers, factory workers and the entire social community. A family harmonious group with the same ideal; passion for her own job, sacrifice, wide open and loyal dialogue to the whole company, to the suppliers, to the collaborations with young designer and architects that together Cucinesse company into the future with the goal of making it best. Cucinesse is not just a single entity, it is the sum of his resources: a company that is structured and it is identified on the human power that composes it. A company in continuous evolution that has known how to grow in tuning with the changes of the market and to affirm her name in the principal markets and that still has much to give.

Nous pensons que derrière le dur travail quotidien de Sergio Pazzaglia, entrepreneur depuis 1979, il y eu un rêve, sans pour cela imaginer tout ce qu'il aurait construit a ce jour. Une procédure et un parcours professionnel guidés par un désir d'en faire profiter a tous: la famille, les collaborateurs, les eployés, les fournisseurs et la société. Un groupe familial cohésif et avec les mêmes idéaux: la passion du métier, le sacrifice, un dialogue ouvert et loyal envers l'entreprise, les fournisseurs, une collaboration avec de jeunes designers et architectes qui, ensemble font de Cucinesse une société qui se projette dans le futur, avec le devoir de le reindre meilleur. Cucinesse n'est pas seulement une personne; mais la somme de ses ressources: une société qui s'est structurée et s'identifie aux forces humaines qui la compose. Une société en évolution constante qui a su grandir en syntonie avec les évolutions du marché et s'imposer dans les marchés principaux et qui doit encore connaître ses plus beaux succès.



I controlli eseguiti in ogni fase della produzione, la cura nelle lavorazioni, l'organizzazione aziendale sottoposta a precisi protocolli garantiscono una Qualità secondo i più alti standard Europei. Grazie alla volontà e all'impegno costante della proprietà ed alla partecipazione attiva dei propri dipendenti e fornitori, Cucinesse è da anni un'azienda in grado di aumentare il carattere innovativo della sue composizioni. Il Servizio di Assistenza al Cliente rappresenta il valore aggiunto nel progetto aziendale di Cucinesse. Un'organizzazione affidabile e dinamica che coinvolge risorse umane pronte ad offrire con passione e competenza tutta l'assistenza tecnica per il montaggio. Un team affiatato con un alto livello di professionalità riconosciuto ed apprezzato.

The controls performed in every phase of the production, the care in the workmanships, the business organization submitted to precise protocols guarantee a Quality according to the highest European standards. Thanks to the wish and the constant commitment of the ownership and the active share of her own employees and suppliers, Cucinesse has been a company able to increase the innovative nature of her compositions over the years. The customer care and the assistance service to the Client represents the added value in the business project of Cucinesse. A reliable and dynamic organization that involves human resources ready to offer with passion and skills the whole technical support for the assembling. An harmonious team with a high-level of professionalism recognized and appreciated.

Les controles effectués a chaque phase de la production, le soin des finitions, l'organisation de la société soumise à des protocoles précis, garantissent une qualité suivant les plus hauts standards européens. Grâce à la volonté et à une implication constante de la direction ainsi qu'à la participation active des employés et fournisseurs, Cucinesse est une société, qui depuis des années, est capable d'augmenter le caractère innovant de ses compositions. Le service au client représente la valeur ajoutée dans la société Cucinesse. Une organisation fiable et dynamique, qui implique les ressources humaines prêtes a offrir avec passion et compétences, toute l'assistance technique pour l'installation. Une équipe unie avec un haut niveau de professionnalisme, reconnue et appréciée.



progetto, grafica e AD
LEONARDI_MARINELLI
ARCHITETTI

foto
LEONFOTO.IT

fotolito
STUDIO 59

stampa
KANDO

cucinesse

Via Brodolini, 21/25
Montelabbate PU
tel +39 0721 491637
fax +39 0721 490868
cucinesse@cucinesse.it
www.cucinesse.it

cucinese